

HYUNDAI
POWER PRODUCTS

PETROL PLANT SHREDDER

HBT196-1

ORIGINAL INSTRUCTIONS

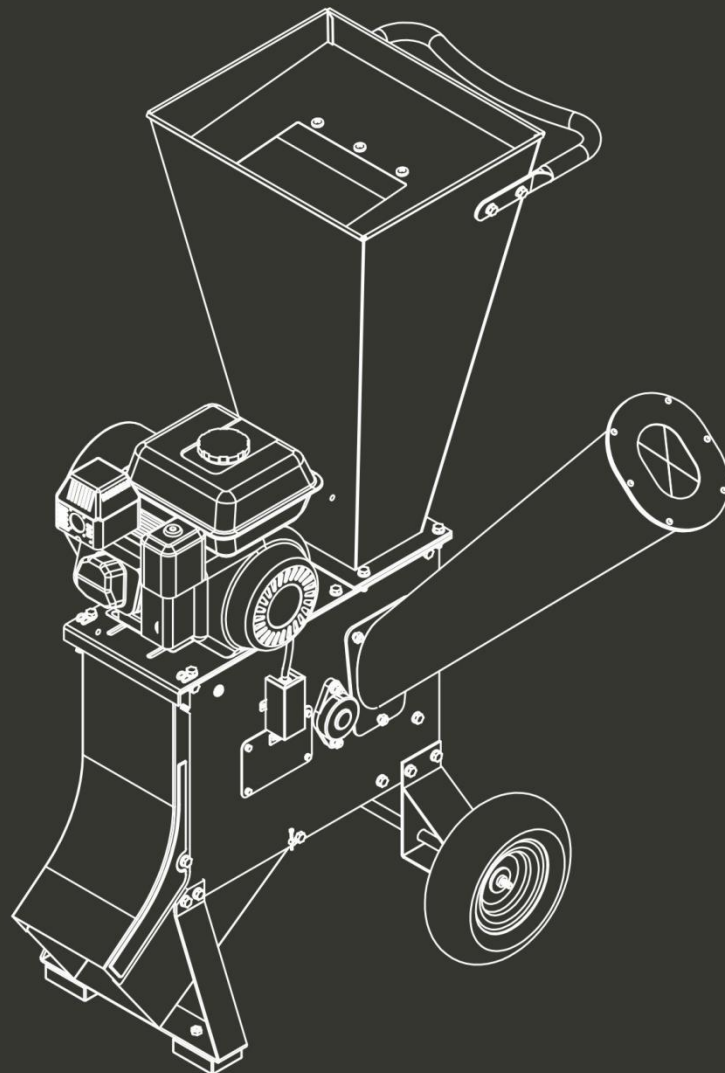

WARNING: Read thoroughly the instruction manual before using this machine!

CONTENTS

1. INTRODUCTION.....	3
2. SAFETY WARNINGS.....	3
3. SYMBOLS.....	5
4. MACHINE DESCRIPTION.....	6
5. START UP INSTRUCTIONS.....	7
6. MACHINE USAGE.....	13
7. MAINTENANCE.....	14
8. TROUBLE SHOOTING.....	17
9. TRANSPORT.....	18
10. STORAGE.....	18
11. RECYCLING AND MACHINE DISPOSAL.....	18
12. DECLARATION OF CONFORMITY.....	19
13. WARRANTY.....	20
14. PRODUCT FAILURE.....	21
15. WARRANTY EXCLUSIONS.....	22

1. INTRODUCTION

Thank you for choosing this machine. We are confident that you will appreciate the quality and performance of this machine.



Warning! Read all safety warnings and all instructions. The failure to observe all warnings and instructions below can result in fire and / or serious injury. Before using this machine, carefully read the information in this manual on correct setup and safe techniques.



The chipper is only designed to shred pieces of wood. It is prohibited to shred any other material (for example metal, stones, plastics and any other material). If you want to shred roots, remove the sand, mud or other residues before shredding. Any other use of the shredder not described here, annuls the warranty responsibility of the manufacturer.



Save all warnings and instructions for future reference. If sold in the future, remember to give this manual to the new owner.

Remember that the machine operator is responsible for the damages and accidents caused to other people or things. The manufacturer will not be responsible for damages caused by improper or incorrect use of this machine.

2. SAFETY WARNINGS

IMPORTANT!

READ CAREFULLY BEFORE USE KEEP FOR FUTURE REFERENCE!

Training

Become familiar with the owner's manual before attempting to operate this equipment.

Preparation

- 1) Do not allow children to operate this equipment;
- 2) Do not operate this equipment in the vicinity of bystanders;
- 3) Do not run engine powered machines in an enclosed area since the exhaust from an engine contains carbon monoxide, which is colorless, odorless, and tasteless; carbon monoxide can be extremely dangerous in enclosed areas;
- 4) Wear ear protection and safety glasses at all times while operating the machine;
- 5) Avoid wearing clothing that is loose fitting or that has hanging cords or ties;
- 6) Only operate the machine in open space (e.g. not close to a wall or other fixed object) and on a firm, level surface;
- 7) Do not operate the machine on a paved or gravel surface where ejected material could cause injury;
- 8) Before starting the machine, check that all screws, nuts, bolts, and other fasteners are properly secured and that guards and screens are in place. Replace damaged or unreadable labels;
- 9) Use extra care in handling fuels. They are flammable and the vapors are explosive. The following points should be observed:
 - use only an approved container;
 - Never remove the fuel cap or add fuel with the power source running. Allow engine and exhaust components to cool before refueling; do not smoke;
 - Never refuel the machine indoors;
 - Never store the machine or fuel container inside where there is an open flame, such as a water heater;

- If fuel is spilled, do not attempt to start the power source, but move the machine away from the area of spillage before starting;
- Always replace and securely tighten the fuel cap after refueling;
- If the fuel tank is drained, this should be done outdoors.

Operation

- 1) Before starting the machine, look into the feeding chamber to make certain that it is empty;
- 2) Keep your face and body away from the feed intake opening;
- 3) Do not allow hands or any other part of the body or clothing inside the feeding chamber, discharge chute, or near any moving part;
- 4) Keep proper balance and footing at all times. Do not overreach. Never stand at a higher level than the base of the machine when feeding material into it;
- 5) Always stand clear of the discharge zone when operating this machine;
- 6) When feeding material into the machine be extremely careful that pieces of metal, rocks, bottles, cans or other foreign objects are not included;
- 7) If the cutting mechanism strikes any foreign objects or if the machine should start making any unusual noise or vibration, shut off the power source and allow the machine to stop. Disconnect the spark plug wire from the spark plug (electric unit disconnect from supply) and take the following steps:
 - Inspect for damage;
 - Check for and tighten any loose parts ;
 - Have any damaged parts replaced or repaired with parts having equivalent specifications.
- 8) Do not allow processed material to build up in the discharge zone; this may prevent proper discharge and can result in kickback of material through the feed intake opening;
- 9) If the machine becomes clogged at the inlet opening or discharge chute shut-off the power source and disconnect the spark plug wire or remove the ignition key before clearing debris in the inlet opening or discharge chute. Keep the power source clear of debris and other accumulations to prevent damage to the power source or possible fire. Remember that operating the starting mechanism on engine powered machines will still cause the cutting means to move;
- 10) keep all guards and deflectors in place and in good working condition;
- 11) Do not tamper with the power source governor settings; the governor controls the safe maximum operating speed and protects the power source and all moving parts from damage caused by over-speed. Seek authorized service if a problem exists;
- 12) Do not transport this machine while the power source is running;
- 13) Shut off the power source and disconnect the spark plug lead (electric unit disconnect from supply) whenever you leave the work area;
- 14) Do not tilt the machine while the power source is running.

Maintenance and storage

- 1) When the machine is stopped for servicing, inspection, or storage, or to change an accessory, shut off the power source, disconnect the spark plug wire from the spark plug (electric unit disconnect from supply), make sure that all moving parts have come to a complete stop and, where a key is fitted remove the key. Allow the machine to cool before making any inspections, adjustments, etc.
- 2) Store the machine where fuel vapour will not reach an open flame or spark. For extended storage periods, run the unit dry of fuel. Always allow the machine to cool before storing;
- 3) When servicing the cutting means be aware that, even though the power source will not start due to the interlock feature of the guard, the cutting means can still be moved by a manual starting mechanism.









Additional safety instructions for units with bagging attachments

a) Shut-off the power unit before attaching or removing the bag.





Position the machine such that it is not necessary to work downwind of the exhaust.



3. SYMBOLS

Warning labels indicate required information for the use of the machine.

	Warning: Danger!
	Caution: Read carefully the manual before use.
	Danger - Rotating blades. Keep hands and feet out of openings while machine is running.
	Keep bystanders away.
	Wear eye and ear protection.
	Do not use as a step.
	Wear protective gloves.
	Wear safety footwear.
	Guarantee sound power level.

In order to guarantee safe and proper use and maintenance of the machine, the following symbols appear on the machine.

	Fuel tank.
	Closed air flow.
	Open fuel key.
	Tortoise = Minimum. Hare = Maximum.
	ON (Machine is ready to function).

0	OFF (Machine cannot function).
HOT 	Warning: Hot surface! Risk of Burns.
OIL	Oil Tank.
	Don't put your hand into the machine.

4. MACHINE DESCRIPTION

4.1 CONDITIONS OF USE

The chipper is only designed to shred pieces of wood. It is prohibited to shred any other material (for example metal, stones, plastics and any other material). If you want to shred roots, remove the sand, mud or other residues before shredding. Any other use of the shredder not described here, annuls the warranty responsibility of the manufacturer. Do not use this machine for any other purpose not intended. The use of this machine for other than the designated operations may result in dangerous situations. Use this machine outdoors, in dry environment and temperature between 5°C to 45°C.

Remember that the machine operator is responsible for the dangers and accidents caused to other people or things. The manufacturer shall not be in any case responsible for damages caused by improper or incorrect use of this machine.

4.2 DETAILED DESCRIPTION OF THIS PRODUCT

1. Hopper
2. Hopper handle
3. ON/OFF switch
4. Chipper Funnel
5. Wheels
6. Leg
7. Discharge chute
8. Starter Handle
9. Exhaust
10. Air filter
11. Fuel tank
12. Plastic cover

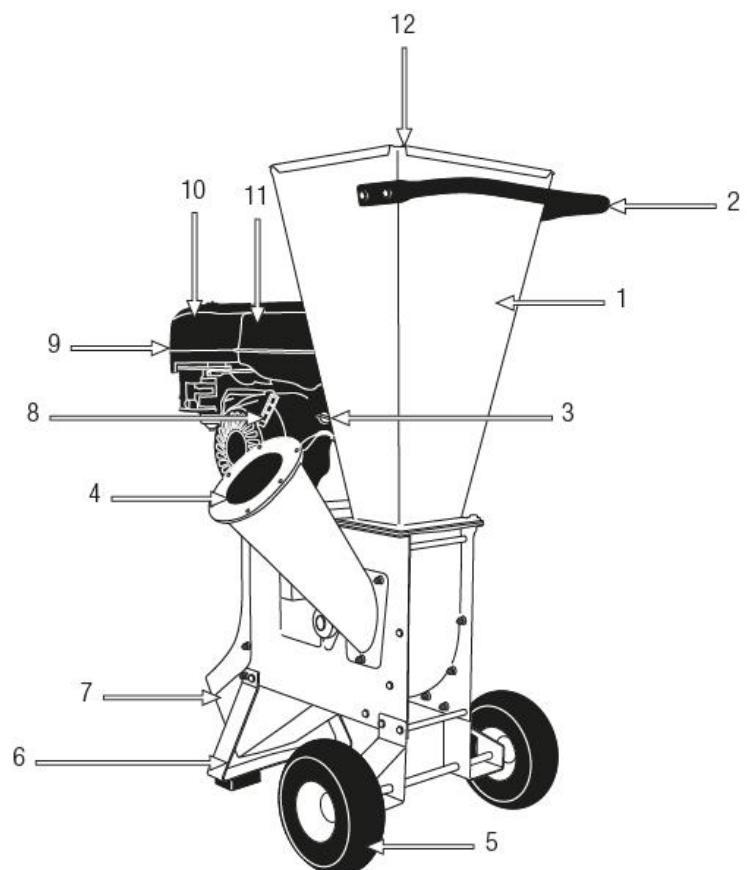

Images and drawings in this manual are approximate and may not correspond with the actual product.

4.3 TECHNICAL CHARACTERISTICS

Model	HBT196-1
Engine	OHV 4-stroke 4.3kW 3600/min
Displacement	212cc
Fuel Type	Unleaded Petrol
Fuel Volume	3.6L
Oil Type	10w-30 mineral Engine Oil
Oil Volume	0.6L
Cutting Capacity	76mm
Blade Speed	2400/min
Size	134*64*88cm
Net weight	75kg
Sound pressure level at operator's ear L _{pA}	95.5dB(A); K=3dB(A)
Guarantee sound power level L _{wA}	116dB(A)

5. START UP INSTRUCTIONS

5.1 UNPACKING AND LIST OF MATERIALS

This machine includes the following items that you will find inside the box:

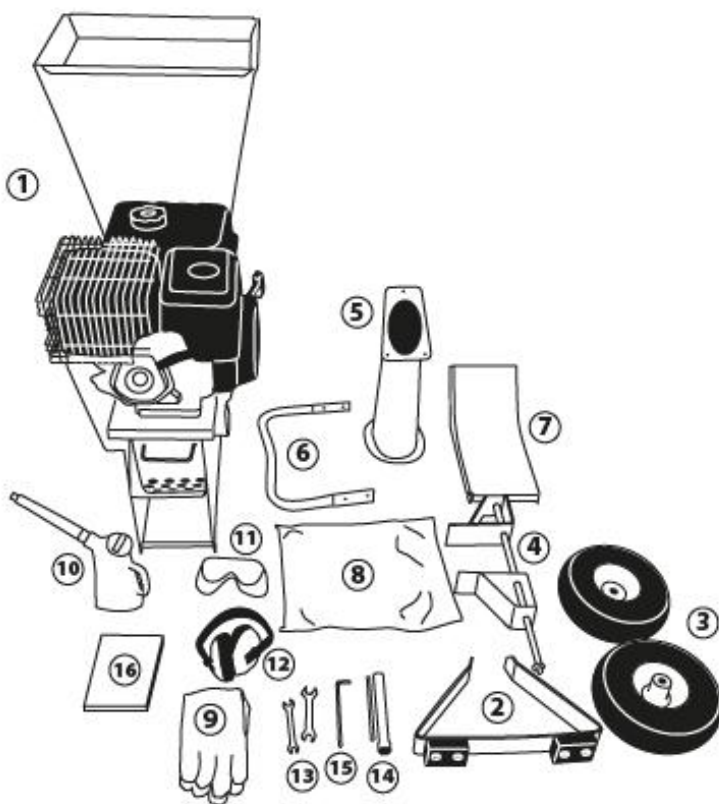

- 1 Machine
- 2 Back Support
- 3 Wheel (×2)
- 4 Axis wheel
- 5 Side Feed Hopper
- 6 Transport handle
- 7 Protector
- 8 Bag
- 9 Gloves (×2)
- 10 Fuel can
- 11 Protective glasses
- 12 Helmets
- 13 Fixed keys (×2)
- 14 Spark plug and dowel wrench
- 15 Allen key
- 16 Instruction Manual

5.2 ASSEMBLY

Step 1. - The fence was pre-mounted on the product, Firstly should remove fence from product for assemble the outlet hopper cover and support.

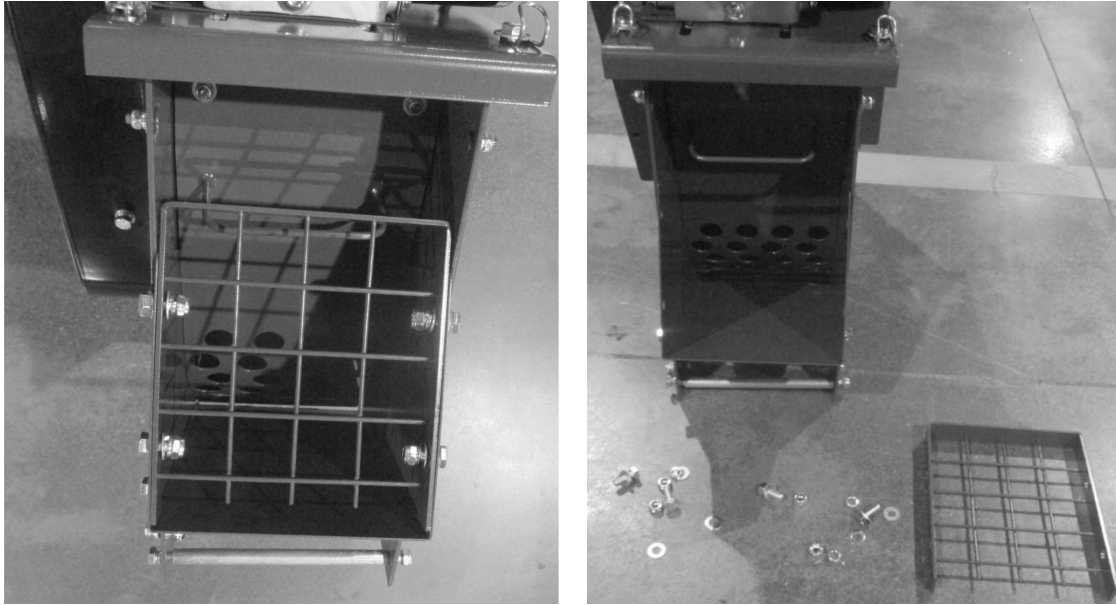

Step 2. - Support feet and outlet hopper cover.

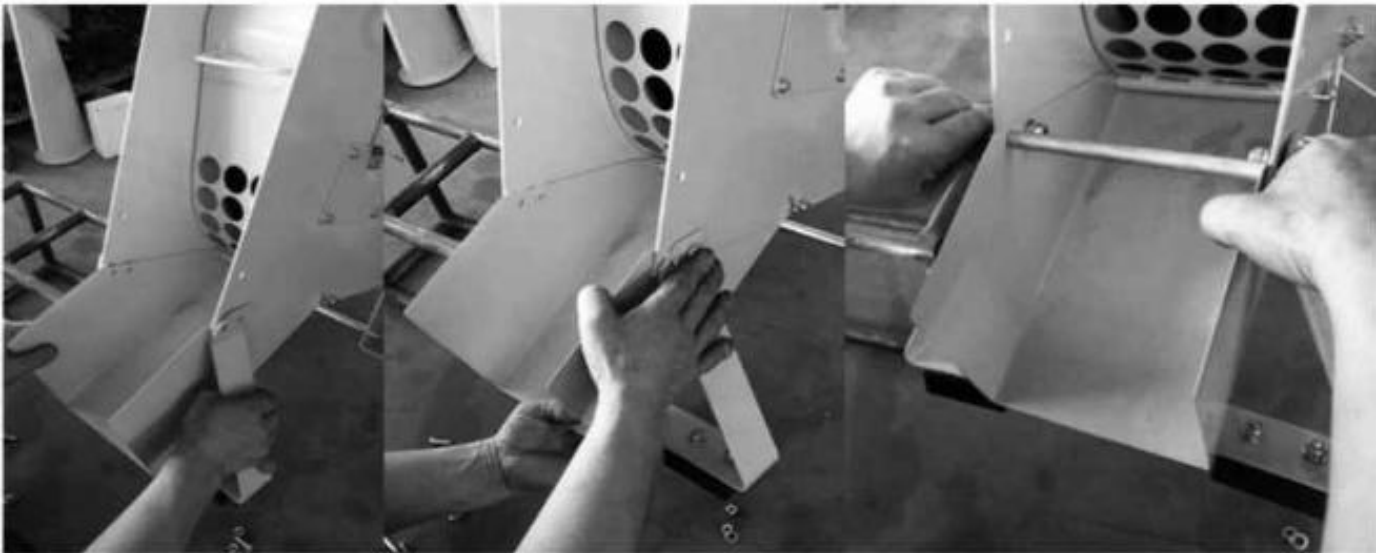

Step 3. -Assemble the fence.



Step 4. -Wheel axle and wheels.

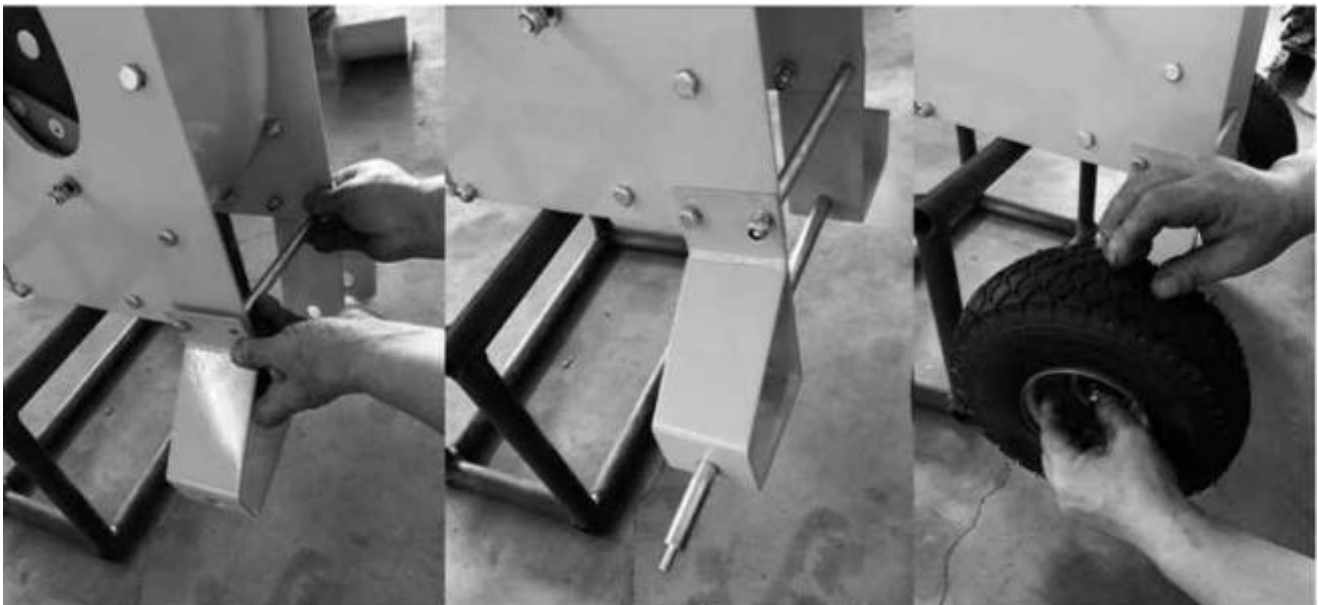

Step 5. -Side feed hopper



Step 6. -Attached transport handle.

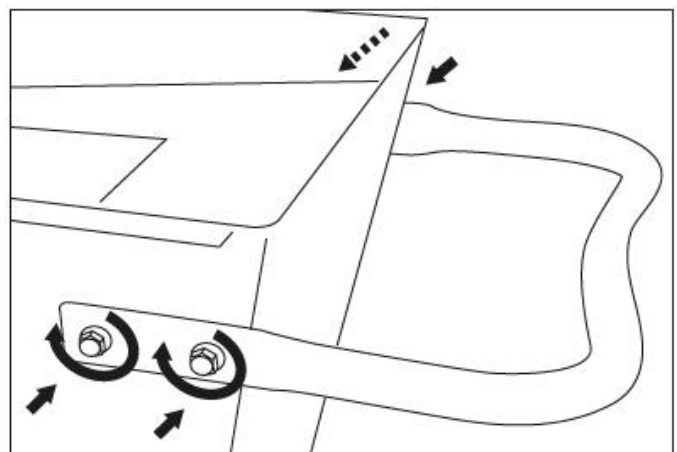

Step 7. - Optional choose (for just electrical starter engine)

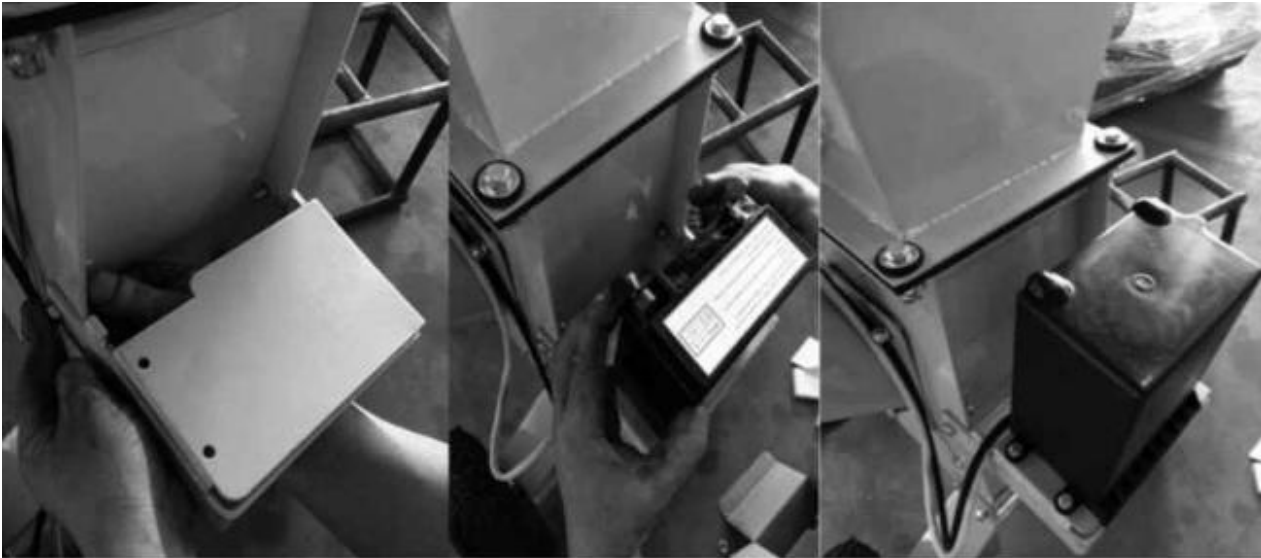

5.3 FUEL AND OIL

IMPORTANT: The fuel used for this machine is highly flammable. If the fuel or the machine ignites, put out the fire with a dry power extinguisher.

Petrol and oil are extremely flammable and explosive under certain conditions. Do not smoke and keep flames, sparks or heat away from the machine.

Use unleaded gasoline 95 octane.

Do not use fuel that has been stored for longer than 2 months. A fuel stored for too long will cause the starting of the machine to be more difficult and result in unsatisfactory engine performance. If the fuel has been in the machine's tank for longer than two months, empty the tank and replace it with fuel in perfect condition.

5.3.1 FILLING THE FUEL TANK

1. Choose a suitable area to perform this operation.
2. Remove the fuel tank cap and fill with fuel.
3. Tightly close the fuel tank's cap and remove all the fuel that spilled with a dry cloth.

WARNING: Stop the engine before refueling.

Do not start the machine in an enclosed room or space. The exhaust gases and fumes from the fuel and oil contain carbon monoxide and harmful chemicals.

In case of a concentration of gases produced by poor ventilation, remove all that impedes the flow of clean air from the work area to improve ventilation. Do not return to work in the area unless you have properly ventilated area and are certain that ventilation is sufficient so that does not happen in this concentration again.

Do not refuel fuel in locations where there is the presence of open flames, sparks or heat sources. Fill the tank always in well-ventilated areas and with the motor stopped. Do not overflow the fuel to overfill the fuel tank. In the event of a fuel leak be sure to remove these leaks completely before starting, move the machine away from the area of spillage and avoid any source of ignition until all vapors are gone.

Separate yourself at least 3 meters from the refueling area before starting the machine.

Add fuel before starting the machine. Never remove the cap of the fuel tank while the engine is running or when the machine is hot.

Do not use fuels such as ethanol or methanol. These fuels will damage the engine of the machine.

5.3.2 ENGINE OIL

For transport reason, your machine's engine comes from the factory without any oil in it. Before starting the engine for the first time you must put oil the engine.

This engine uses quality oil for 4-stroke, 10w-30 viscosity.

Filling the oil sump:

- Place the machine on a flat, horizontal and uncluttered surface.
- Unscrew the oil filler cap.

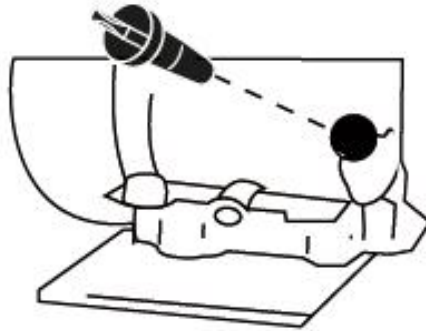

- Insert the filled 0.6L of oil tube for 6.5HP engine, 1.1L of oil tube for 15HP engine.
- Wait 1 minute for the oil to completely go down to the crankcase.
- Clean the dipstick from the oil with a cloth.
- Insert the rod and screw on the oil cap.
- Unscrew the plug again and check the mark left by oil on the dipstick. The mark left by the oil must be between the minimum and maximum marks.
- If the mark is below the minimum, add a little more oil and recheck.
- If the mark is above the maximum, you will have to remove oil from the crankcase. To do this, tilt the machine and let out a little oil (put a container at the end of the tube to prevent oil spilling on the machine or the ground).

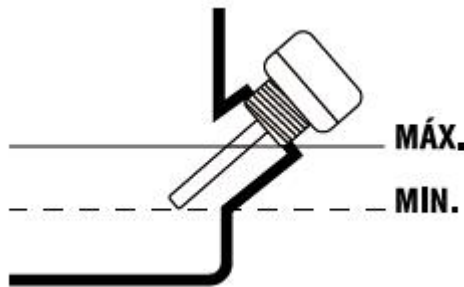

5.4. START-UP

5.4.1 CHECKPOINTS BEFORE COMMISSIONING

The machine must be used as conformed under the following instructions:

Maintain hands, other extremities and clothes clear of the entry hopper, clear of the exit shoot and clear of all rotating elements.

Maintain a good balance on both feet. Do not lean on the machine.

Maintain yourself well clear of the exit area whilst the machine is working.

If the blades hit a strange object (any other object different to wood) or if the machine starts to make strange noises and/or it vibrates in an abnormal way, stop the engine so that the blades stop turning. Take the machine to your nearest service agent for repair.

If the machine gets stuck, you must stop it and wait for the blades to stop turning.

The use of working gloves, ear protection and working glasses is mandatory.



The machine is designed only for outdoor use. Avoid using the machine in outdoor areas with a high probability of exhaust fumes.

The machine must be used by only one person at a time.

Never insert your hands in the entry chute until the machine has been stopped and the blades have stopped rotating.

The pieces of wood that might have got stuck transversally must only be removed when the machine has been stopped and the blades have stopped rotating.

Transport of the machine should be carried out by two persons to avoid possible injuries.

5.4.2 STARTING THE ENGINE

Before starting engine make sure check the engine oil and fuel tank.

1. Turn the fuel lever to the ON position (Pic. 11) (11.1).
2. Set the choke lever to the CHOKE(OFF) position (Pic. 12) (12.1).

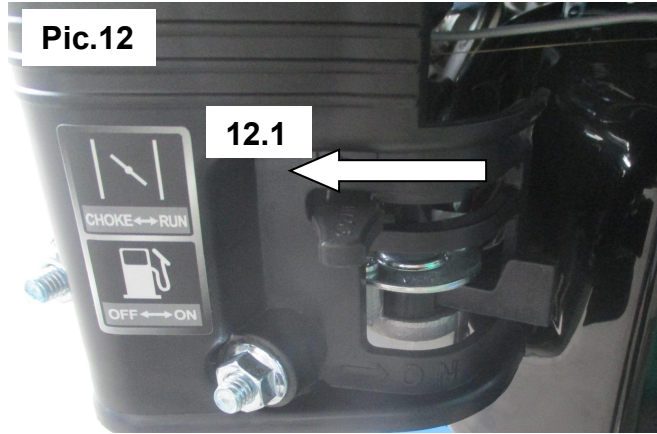
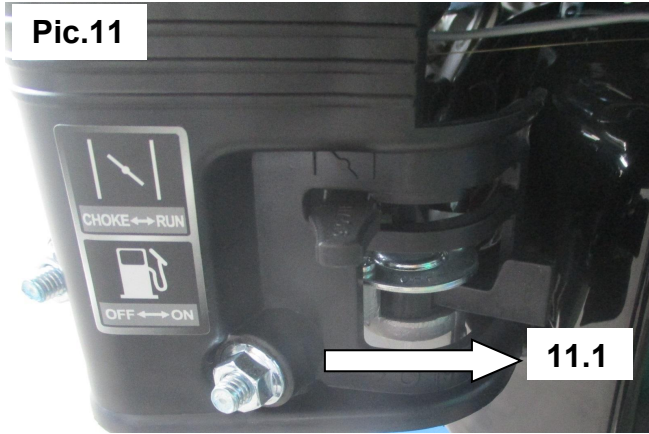

3. Turn the engine ON/OFF switch to the ON position (Pic.13) (13.1).
4. Hold down the engine firmly with one hand on the frame. With the other hand grip the recoil starter cord handle and pull slowly until resistance is felt indicating that the recoil starter is engaged. When resistance is felt pull the cord sharply (Pic.14). Continue this procedure until the engine starts.

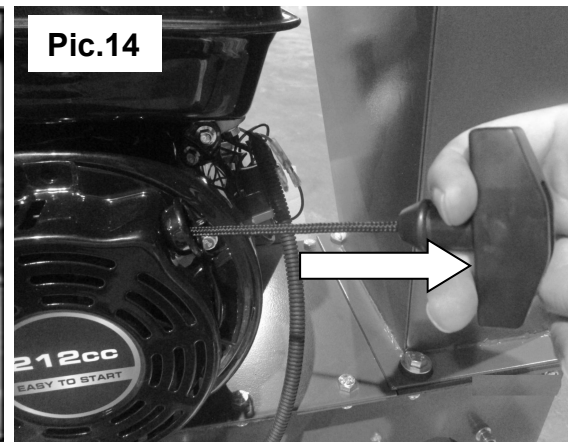
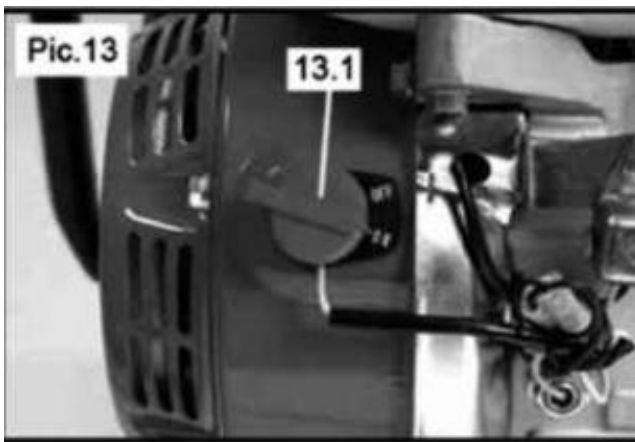

5. When the engine has been successfully started and is running smoothly return the choke lever to the RUN(ON) position (Pic. 15) (15.1).
6. When the engine is running, the speed can be adjusted by moving the throttle control lever (Pic.16) (16.1) to the high (indicated by a hare), medium or low position (indicated by a tortoise).

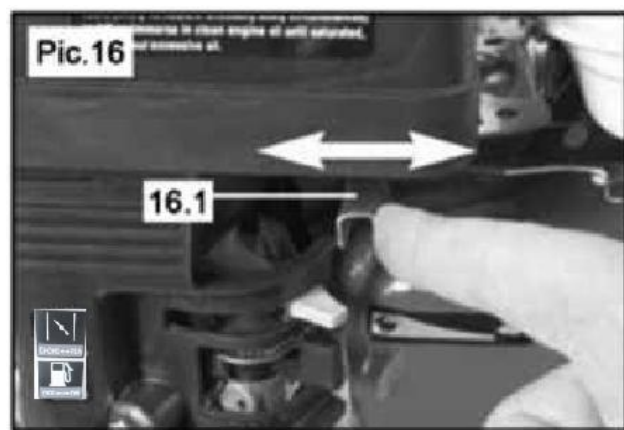
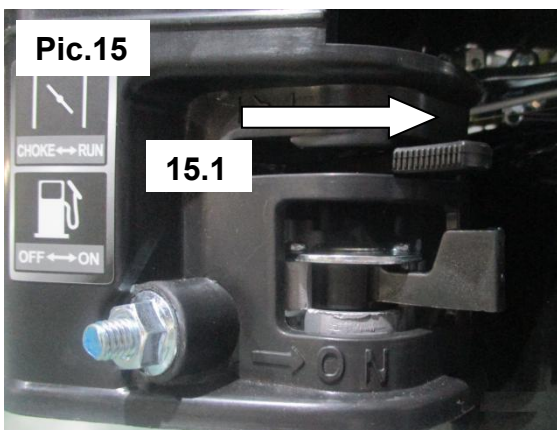

5.4.3 STOP THE ENGINE

Note: If the machine should start to make an unusual noise, stop the machine immediately, allow the engine to cool and inspect thoroughly.

1. To stop the engine, turn the engine ON/OFF switch to the OFF position, as in Pic. 17 (17.1).
2. When the engine has stopped fully, turn the Fuel lever to the OFF position also, as shown in Pic.18 (18.1).

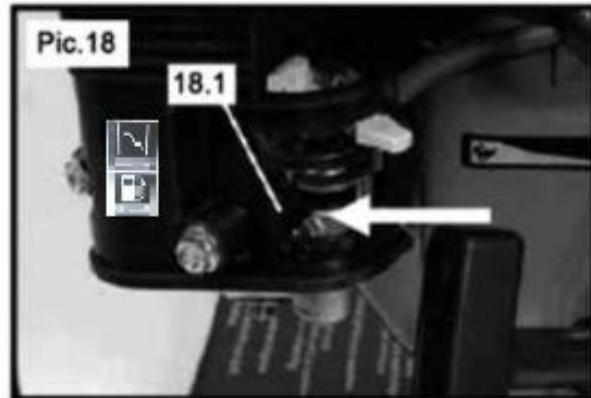

6. MACHINE USAGE

6.1. CHIPPING BRANCHES

1. Stand to the side of the Hopper, ensuring you have a stable stance and firm footing.
2. When placing long branches into the chipper funnel, remove twigs and smaller branches so that you are feeding a thin, straight piece into the machine.
3. Put the big end of branch to the chipper funnel . The branch will be pulled by the rotating blade automatically. You will be free to push the branch into the chipper funnel (see Pic.20).



4. When finished chipping, turn OFF the machine, allow all moving parts to come to a complete stop, and disconnect the spark plug wire before moving the machine, emptying the bag, unclogging the inlets or outlets, filling the gas tank, or performing maintenance and repairs.

Chipping Tips:

- DO NOT feed material in excess of the diameter indicated on the funnel cover into the funnel. Large branches will cause the motor to stall.
- Chipping wood when it is green is easier on the machine. The blades will stay sharper longer.
- The chipper/shredder will work best if the blades are sharp. Rotate, sharpen, or replace the blades as soon as chipper/shredder performance begins to deteriorate.

6.2 SHREDDING BRANCHES, TWIGS & LEAVES

- A. Gather the brush, twigs or leaves and slowly place them into the Hopper. DO NOT try to stuff too much material in at one time or the machine will jam.
- B. Do not attempt to force the materials in. The machine is designed to quickly and safely take the branches from you.
- C. If necessary, use a thick branch to push materials into the Hopper, as seen in Pic. 19. Do not place your hands in the Hopper/Chute.



D. Turn OFF the machine, allow all moving parts to completely stop, and disconnected the spark plug wire before moving the machine, emptying the bag, unclogging the inlets or outlets, filling the gas tank, or performing maintenance and repairs.

Shredding Tips:

- ◆ Feed material into the chipper/shredder slowly, if the motor begins to bog down, you are feeding too fast.
- ◆ Roots and dirty material will dull or damage the blades.
- ◆ Remove the chips often. Allowing the chips to pile up to the outlet will cause the outlet to clog.
- ◆ Avoid shredding wet leaves or brush to reduce clogging. If you must shred wet material, alternate wet and dry material.

NOTE: When you are not actively shredding or chipping, move the Throttle lever to the lowest possible setting. If you are moving away from the machine, and the machine is to become unsupervised, the machine must be switched off.

7. MAINTENANCE

WARNING: Turn OFF the machine, allow all moving parts to come to a complete stop, and disconnect the spark plug wire before moving the machine, emptying the bag, unclogging the inlets or outlets, filling the gas tank, or performing maintenance and repairs.

Warning - danger of rotating cutting means!

7.1 VISUAL INSPECTION

Before and after every use of the wood chipper, it is recommended that the following inspection process take place. This is quick and easy, and ensures your safety as well as the machine's performance.

1. Check the Hopper, Chute, Funnel and guards for cracks, holes and loose bolts.
2. Check the frame and base of the machine for cracks or damage.
3. Check all the bolts and screws to ensure tightness.
4. Wear gloves, check the blades are not cracked or loose.
5. Check the engine oil level using a dipstick.

7.2 CLEANING

It is strongly recommended to clean the machine after every use. After use, turn off the machine, allow the engine to cool fully, and remove the spark plug.

Brush off or vacuum excess wood chippings and wipe off the remaining dust from the exterior of the machine with a dry cloth. Do not expose the machine to water or attempt to clean by pouring water on/into it. Remove any chips or debris from the hopper and the discharge chute.

It is increasingly difficult to clean this machine the longer you let it sit unclean. The machine's performance will naturally decrease if it is not properly cared for.

To clean the engine from built-up resins, you may need to purchase an engine cleaner. These are available at most auto-parts stores or online.

7.3 MAINTENANCE OF ENGINE

7.3.1 SPARK PLUG

After every 50 hours of running the spark plug should be removed. Check the color of the deposits on the end of the spark plug and remove all deposits with a stiff brush, a brass wire brush is ideal. Check the spark plug gap (Pic.21) and adjust if required. The correct gap should be 0.7 to 0.8mm.

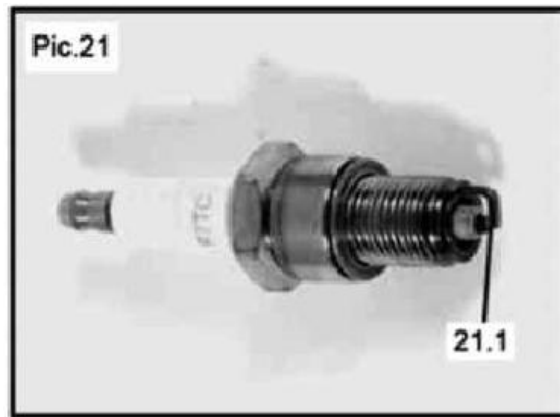

7.3.2 ENGINE OIL REPLACEMENT

The oil should be replaced after approximately 68 hours of use. It is recommended you maintain an estimate of this by tracking your usage of the machine.

1. As per normal start-up, ensure the machine is on a flat, dry surface and follow the previous instructions to start-up. Allow the engine to warm for several minutes before turning off the engine.
2. Remove the Oil Filler Cap as seen in Pic.8.
3. Place an oil pan under the engine to catch the oil. Remove the Oil Drain Plug (also displayed in Pic. 8) in order to drain the oil fully. A tube or similar device is recommended to avoid spilling the oil.
4. Check the Oil Drain Plug, Gasket, and Oil Filler Cap to ensure each item is not damaged.
5. Add fresh engine oil up to the upper level of the dipstick, as seen in Pic. 9.

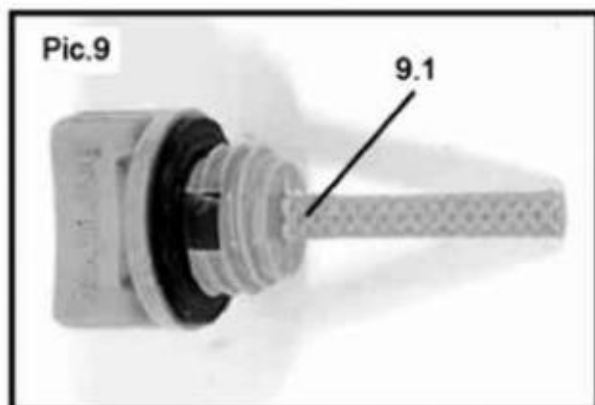
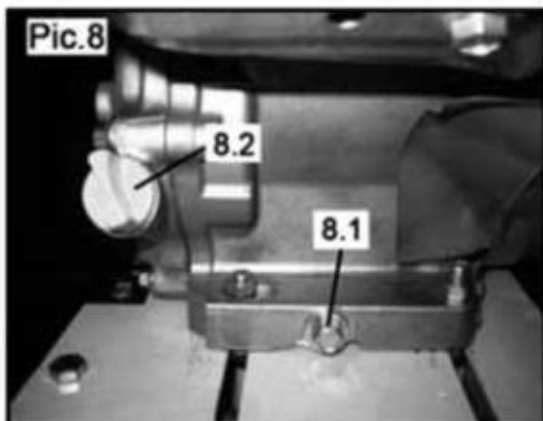

7.3.3 AIR FILTER

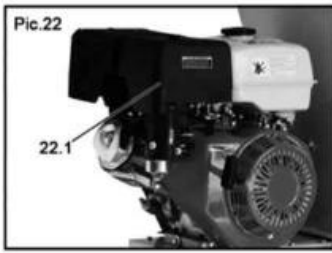

After approximately 100 hours of use, or every month (whichever is sooner), the Air Filter should be removed and cleaned thoroughly. The Air Filter is displayed in Pic.22. During this cleaning process, the Air Filter should also be thoroughly inspected for damage and deterioration. We recommend a water-based degreasing agent. Allow to dry fully before replacing the Air Filter.

NOTE: Never attempt to run the machine without an Air Filter inserted.

7.3.4 FUEL TANK FILTER



After approximately 150 hours of use, or every 3 months (whichever is sooner), the Fuel Tank Filter should be removed and cleaned thoroughly. The Fuel Tank Filter is displayed in Pic.23. As with cleaning the Air Filter, we recommend cleaning the Fuel Tank Filter with a water-based degreasing agent.

7.4 REPLACE THE BLADES

Sharpen or replace the blades as soon as the chipping performance begins to deteriorate, or if you notice the blade with chips or cracks.

To perform this procedure:

1. Turn off the machine, allow all moving parts to come to a complete stop, and disconnect the spark plug wire!
2. Remove the side cover plate to expose the blades. (the side cover plate is inserted to upper, so just pull down.)



3. Remove one blade, rotate the impeller, and remove the second blade.
4. Have the original blades professionally sharpened, or order a replacement set, then re-install the blades.
5. Replace the side cover plate and re-attached the spark plug wire.

7.5 REPLACE THE V-BELT

Replace or tighten the V-belt you notice the motor running and the chipper blades are not spinning.

1. Turn off the machine, allow all moving parts to come to a complete stop, and disconnect the spark plug wire!
2. Remove the V-belt cover as shown in Pic. 25.

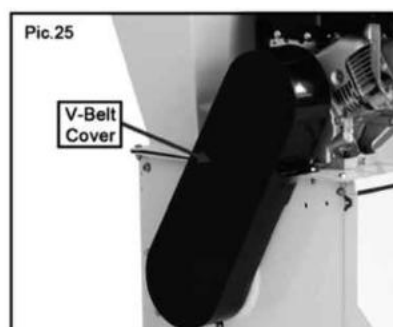

3. Roll the belt off from the pulleys and install the new belt.
4. Replace the V-belt cover and re-attached the spark plug wire.

7.6 PERIODIC MAINTENANCE

Perform regular inspections of the machine in order to ensure effective operation of the machine and prevent risk of injury to machine and user. Replacement parts should be purchased at the official service dealer.

The use of non-official spare parts may cause risk of accident, injury to the user and scrapping of the machine.

Perform maintenance frequently as indicated in the following table:

PIECES	ACTION	Each use	First month /20 hours	First 3 months /50 hours	First 8 months / 100 hours	Each year/ 300 hours
Engine Oil	Level test	•				
	Change		•		•	
Air filter	Check	•				
	Cleaning			•		
	Replace					
Tension transmission belt	Cleaning and adjustment		•		•	
Spark plug	Adjustment				•	
	Replace					•
Muffler	Cleaning				•	
Fuel sediment deposits	Cleaning					•
Filter and fuel tank	Cleaning					•
Fuel inlet tube	Check and replace if necessary					•

8. TROUBLE SHOOTING

If the machine does not start, check the compression of the engine and the spark from the spark plug. Depending on the symptoms that you notice, you can discover the probable cause and solve the problem.

Symptom	Possible Cause	Possible Solution
Engine will not start.	Control levers are not in correct positions for starting	Make sure the ON/OFF switch is ON, the fuel shut-off valve is open, and the choke and throttle controls are in the start position
	Spark plug wire is not connected to the spark plug, or the spark plug is bad	Connect the spark plug wire or replace the spark plug
	No gas, or gas is old and state	If empty, fill the tank. If full, drain the gas, then fill the tank with fresh gas
	Air filter is dirty	Clean out the air filter
	Engine oil is low	Add oil to the engine
	Blocked fuel line	Clean out the fuel line
Engine does not run smoothly	Engine is warm, and the choke is still in the CHOKE position	Move the choke to the RUN position
	Air filter is dirty	Clean the air filter

	State fuel, water or dirt in fuel, blocked fuel line	Drain the fuel tank, clean out the fuel line, and fill the tank with fresh gas
Engine overheats	Chips and sawdust around the motor	Clean off the motor
	Dirty air filter	Clean out the air filter
Machine vibrates or makes unusual noises	Loose or damaged parts	Check the blades, hammers, impeller, and all connections. Tighten, repair, or replace any loose or damaged parts
	Impeller or blades have woody residue or chunks stuck to them	Clean the impeller and blades
Chipper/shredder no longer chips or shreds well	Dull or damaged blades and hammers	Sharpen or replace blades and check the hammers for damage.
	Loose, worn, or damaged V-belt	Replace or tighten V-belt
Chips do not come out of the discharge chute or come out slowly	Discharge chute or hopper is clogged	Turn OFF the motor, disconnect the spark plug, then clean out the machine
	Insufficient motor PRM's	Move the throttle to FAST

9. TRANSPORT

Never lift or transport the rotary machine while the engine is running. It is necessary to always turn off the engine when transporting the machine between different working areas.

Once the machine is turned off, wait 5 minutes to allow it to cool before transporting it. The machine's exhaust pipe will remain hot after turning off the engine.

If you have to raise the machine, check the weight of the machine in the technical characteristics before lifting it to ensure that it is a weight that you can withstand.

Transport of the machine should be carried out by two persons to avoid possible injuries.

10. STORAGE

Once the machine is off, wait 5 minutes for it to cool down before storing the machine. The machine's exhaust pipe will remain hot after turning the engine off. Do not ever store the machine in places near flammable materials (dried grass or wood...), gas or fuels.

Be sure to store the machine in a place not accessible to children or that it creates possible danger for anyone and that is dry, clean and at a temperature between 0°C to 45°C.

If you plan to store the machine in a closed place, first empty the fuel. Vapors could come into contact with a flame or hot body and ignite. If the fuel tank has to be emptied, this must be done outdoors and according to the regulations of recycling.

To reduce the risk of fire, keep the engine, muffler and fuel tank clean by eliminating the remains of cut material, oil and grease.

11. RECYCLING AND MACHINE DISPOSAL

Protect the environment. Recycle this machine's used oil by taking it to a recycling center. Do not pour used oil in drains, land, rivers, lakes, or seas.

Dispose of your appliance sustainably. We should not get rid of machines with domestic waste. Plastic and metal components can be classified according to their nature and recycled.

12. DECLARATION OF CONFORMITY



BUILDER SAS

32 rue Aristide Bergès - Z.I. du Casque - 31270 Cugnaux - France

Declare that the following tool:

Petrol Plant Shredder

HBT196-1

Serial number: 20240506372-20240506839

Is in conformity with the requirements of the Directive Machine 2006/42/EC and to the followings

Europeans Directives:

EMC Directive 2014/30/EU

ROHS Directive 2015/865/EU amending 2011/65/EU

Emission directive (EU) 2016/1628

Noise Directive 2000/14/EC and 2005/88/EC Annex X

This tool is also in conformity with the following these standards:

EN 13683: 2003+A2:2011

EN ISO14982: 2009

Sound pressure level at operator's ear: 95.5 dB(A) K=3dB(A)

Guarantee sound power level: 116 dB(A)

Responsible of the technical file: Julia Zou

Cugnaux, 28/02/2024

Philippe MARIE / PDG

13. WARRANTY

HYUNDAI

WARRANTY

The manufacturer guarantees the product against defects in material and workmanship for a period of 2 years from the date of the original purchase. The warranty only applies if the product is for household use. The warranty does not cover breakdowns due to normal wear and tear.

The manufacturer agrees to replace parts identified as defective by the designated distributor. The manufacturer does not accept responsibility for the replacement of the machine, in whole or in part, and/or ensuing damage.

The warranty does not cover breakdowns due to:

- insufficient maintenance.
- abnormal assembly, adjustment or operations of the product.
- parts subject to normal wear and tear.

The warranty does not extend to:

- shipping and packaging costs.
- using the tool for a purpose other than that for which it was designed.
- the use and maintenance of the machine done in a manner not described in the user manual.

Due to our policy of continuous product improvement, we reserve the right to alter or change specifications without notice. Consequently, the product may be different from the information contained therein, but a modification will be undertaken without notice if it is recognized as an improvement of the preceding characteristic.

READ THE MANUAL CAREFULLY BEFORE USING THE MACHINE.

When ordering spare parts, please indicate the part number or code, you can find this in the spare parts list in this manual. Keep the purchase receipt; without it, the warranty is invalid. To help you with your product, we invite you to contact us by phone or via our website:

- **+33 (0)9.70.75.30.30**
- **<https://services.swap-europe.com/contact>**

You must create a "ticket" via the web platform.

- Register or create your account.
- Indicate the reference of the tool.
- Choose the subject of your request.
- Describe your problem.
- Attach these files: invoice or sales receipt, photo of the identification plate (serial number), photo of the part you need (for example: pins on the transformer plug which are broken).



14. PRODUCT FAILURE

WHAT TO DO IF MY MACHINE BREAKS DOWN?

If you bought your product in a store:

- a) Empty the fuel tank if your product has one.
- b) Make sure that your machine is complete with all accessories supplied, and clean! If this is not the case, the repairer will refuse the machine.

Go to the store with the complete machine and with the receipt or invoice.

If you bought your product on a website:

- a) Empty the fuel tank if your product has one..
- b) Make sure that your machine is complete with all accessories supplied, and clean! If this is not the case, the repairer will refuse the machine.
- c) Create a SWAP-Europe service ticket on the site: <https://services.swap-europe.com> When making the request on SWAP-Europe, you must attach the invoice and the photo of the nameplate (serial number).
- d) Contact the repair station to make sure it is available before dropping off the machine.

Go to the repair station with the complete machine packed, accompanied by the purchase invoice and the station support sheet downloadable after the service request is completed on the SWAP-Europe site

For machines with engine failure from manufacturers BRIGGS & STRATTON, HONDA and RATO, please refer to the following instructions.

Repairs will be done by approved engine manufacturers of these manufacturers, see their site:

- <http://www.briggsandstratton.com/eu/fr>
- <http://www.honda-engines-eu.com/fr/service-network-page;jsessionid=5EE8456CF39CD572AA2AEEDFD290CDAE>
- <https://www.rato-europe.com/it/service-network>

Please keep your original packaging to allow for after-sales service returns or pack your machine with a similar cardboard box of the same dimensions.

For any question concerning our after-sales service you can make a request on our website <https://services.swap-europe.com>

Our hotline remains available at +33 (9) 70 75 30 30.



15. WARRANTY EXCLUSIONS

THE WARRANTY DOES NOT COVER:

- Start-up and setting up of the product.
- Damage resulting from normal wear and tear of the product.
- Damage resulting from improper use of the product.
- Damage resulting from assembly or start-up not in accordance with the user manual.
- Breakdowns related to carburetion beyond 90 days and fouling of carburetors.
- Periodic and standard maintenance events.
- Actions of modification and dismantling that directly void the warranty.
- Products whose original authentication marking (brand, serial number) has been degraded, altered or withdrawn.
- Replacement of consumables.
- The use of non-original parts.
- Breakage of parts following impacts or projections.
- Accessories breakdowns.
- Defects and their consequences linked to any external cause.
- Loss of components and loss due to insufficient screwing.
- Cutting components and any damage related to the loosening of parts.
- Overload or overheating.
- Poor power supply quality: faulty voltage, voltage error, etc.
- Damages resulting from the deprivation of enjoyment of the product during the time necessary for repairs and more generally the costs related to the immobilization of the product.
- The costs of a second opinion established by a third party following an estimate by a SWAP-Europe repair station
- The use of a product which would show a defect or a breakage which was not the subject of an immediate report and/or repair with the services of SWAP-Europe.
- Deterioration linked to transport and storage*.
- Launchers beyond 90 days.
- Oil, petrol, grease.
- Damages related to the use of non-compliant fuels or lubricants.

* In accordance with transport legislation, damage related to transport must be declared to carriers within 48 hours maximum after observation by registered letter with acknowledgement of receipt.

This document is a supplement to your notice, a non-exhaustive list.

Attention: all orders must be checked in the presence of the delivery person. In case of refusal by the delivery person, it you must simply refuse the delivery and notify your refusal.

Reminder: the reserves do not exclude the notification by registered letter with acknowledgement within 72 hours.

Information: Thermal devices must be wintered each season (service available on the SWAP-Europe site). Batteries must be charged before being stored.

HYUNDAI
POWER PRODUCTS



For inquiries, please contact:

BUILDER SAS

32 rue Aristide Bergès - Z.I. du Casque - 31270 Cugnaux - France

Tél.: +33(0)5.34.502.502 Fax.: +33(0)5.34.502.503

<http://www.hyundaipower-fr.com/>

Fabriqué en République Populaire de Chine(PRC)